



Mesure du geoïde marin avec le système CaINaGEO (GNSS)

Cédric Brachet, Michel Calzas, Christine Drezen, Lionel Fichen, Antoine Guillot
CNRS - INSU -DT, Bâtiment IPEV, CS 50074, 29280 Plouzané - France

Phillipe Téchiné, Laurent Testut
LEGOS UMR5566, 14 avenue Edouard Belin, 31400 Toulouse - France

Pascal Bonnefond
Observatoire de Paris - SYRTE - 77 Avenue Denfert Rochereau 75014 Paris - France

Olivier Laurain
GEOAZUR UMR7329- Observatoire de la Côte d'Azur - 250 rue Albert Einstein - 06560
Valbonne - France

Valérie Ballu, Etienne Poirier
LIENSs UMR7266- 2 rue Olympe de Gouges - 17000 La Rochelle - France

Nicolas Picot
CNES - DSO/OT/AL- 18 avenue Edouard Belin - 31400 Toulouse - France



1- Le projet: FOAM: From Ocean to inland waters Altimetry Monitoring

The determination of mean sea level variations with accuracy below 1 mm/yr is a central question in the current debate on climate change and its impact on the environment including oceanic circulation features [Bindoff et al., 2007; Cazenave and Nerem, 2004]. To answer this, oceanography needs very accurate time series from satellite altimetry but also longer series from tide gauges data. In both cases, problems in geodesy are much more difficult to solve, taking into account the 2.5 cm overall accuracy objective for Jason/OSTM missions on Sea Surface Height.

From the space point of view, orbit quality and reference system (e.g. ITRF) are of particular importance (~1 cm) but error budget on the altimetric measurements (~1.5 cm on range) is also at the same level. From the terrestrial point of view, the geodetic link of tide gauges into the space reference frame defined by satellite altimetry is also one of the most important problems in geodesy. These aspects lead us to develop ultra-precise validation and calibration techniques, including insitu absolute calibration experiment.

These components - orbit, measurements, corrections and their calibrations - form the basis of all the error budgets published in the framework of the TOPEX/Poseidon (T/P) and Jason-1&2 missions during both geophysical evaluation and scientific results phases [Fu et al., 1994; Ménard et al., 2003; Lambin et al., 2010]. They have permitted: (i) to constrain the results of the mission giving limits to the interpretation of altimetric signals, (ii) to indicate the possible improvement sources and (iii) to contribute to the development of new evaluation, validation and calibration methods.

In collaboration with other investigators of the Ocean Surface Topography Science Team working at understanding the coupling effect between climate and global changes of sea level and inland water stocks, our contribution will be dedicated to a detailed error analysis that contribute to assemble a Climate Data Record from past, current and future missions. The system should be used for Jason 3, Sentinel and SWOT CAL/VAL satellites.

PI: Pascal Bonnefond, Astronome, Laboratoire Syrte, Observatoire de Paris
Projet financé par le CNES sur appel à projet CAL/VAL Altimetry



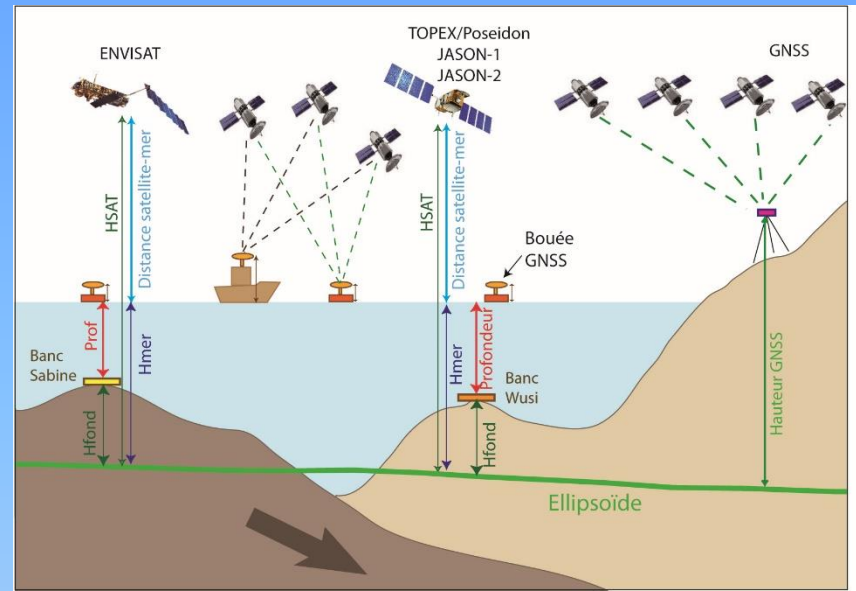
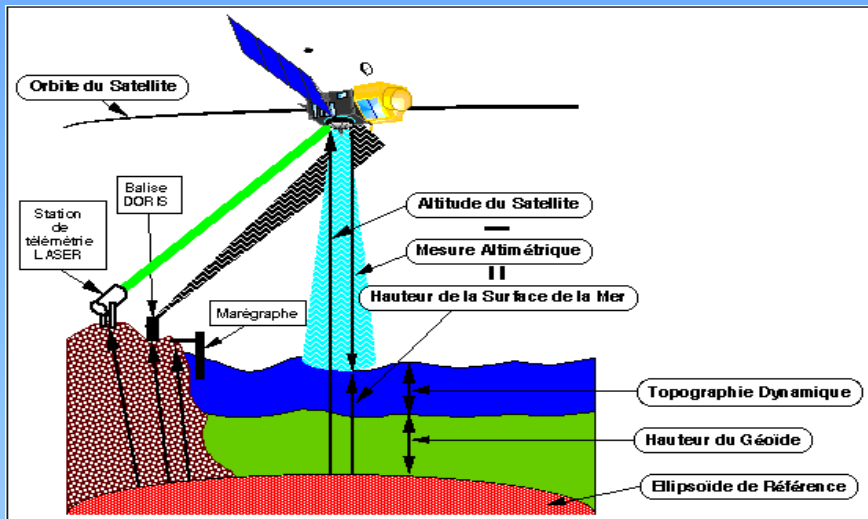

Par définition, le géοide définit la surface de la Terre. ° Le géοide est la surface équipotentielle de pesanteur qui coïncide avec la surface d'équilibre des mers prolongée dans les continents.

L'ellipsoide de révolution ("sphère aplatie aux pôles") est un modèle mathématique utilisé pour exprimer des coordonnées géographiques afin d'effectuer des calculs sur une surface proche de celle de la terre. Il existe de nombreux modèles d'ellipsoïdes (ex WGS84 ou GRS80)



données hautes fréquences des GDR (Geophysical Data Record) Traitements OCA (Bonnetfond/Laurain)



$$\text{SSH} = \text{HSAT} - (\text{RANGE} + \text{IONO} + \text{WET} + \text{DRY} + \text{SSB}).$$



- Orbite: standard GDR-C et GDR-D (champ de gravité variable)
- Range : retracker ocean, +/- 20 km (altimètre)
- Ionosphère :
 - dual frequency pour TP/J1/J2
 - Modèle GIM-KU pour Envisat
- Troposphère sèche: ECMWF
- Troposphère humide: radiomètres
- Ssb: basé sur des modèles empiriques
- Geoide: EGM08 (d'après Bouin et al. 2009)
- Marées terrestres, polaires et surcharge océanique (GDR)
- Pas de marée océanique, ni baromètre inverse.



Ondulations permanentes de la surface 'moyenne' de la mer (géoïde) → Bathymétrie

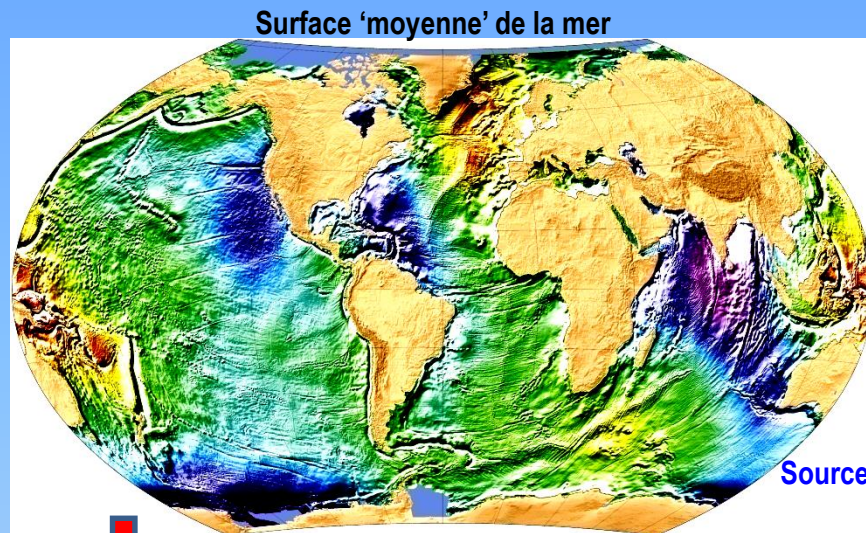
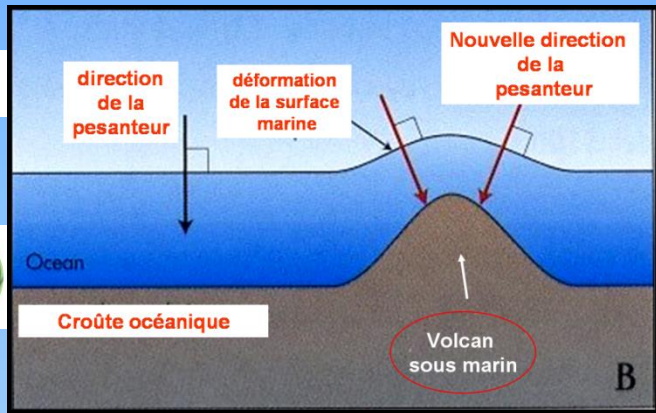

Topographie sous-marine par altimétrie spatiale
Sea floor topography from satellite altimetry

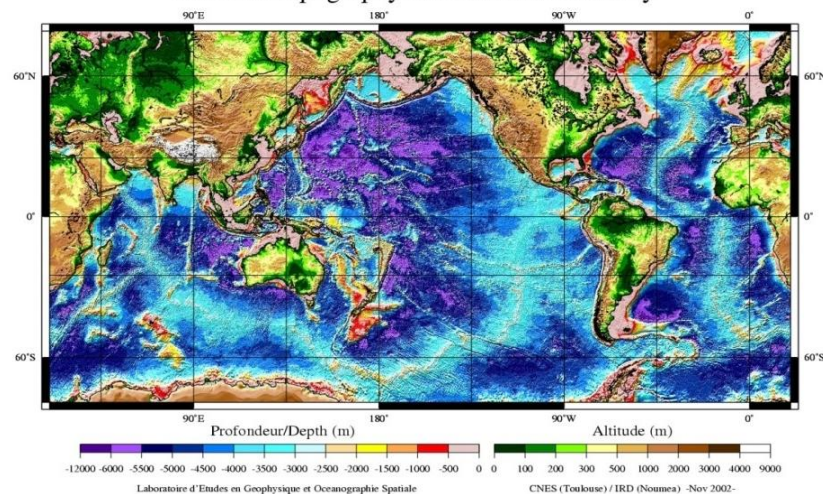



- 2 construction du système

Specifications:

-towed up to 15 knots...whatever sea state...

-don't lose satellite tracking

stability: as best as possible (<1 cm extra movement)

-autonomy: at least 5 days

-sampling: 1 to 50 Hz (to monitor waves)



Mouvements d'un bateau selon les trois axes, 6 degrés de liberté :

Translation: 1- pilonnement, 2- embardée, 3- cavalement,
Rotation: 4- lacet, 5- tangage, 6- roulis.

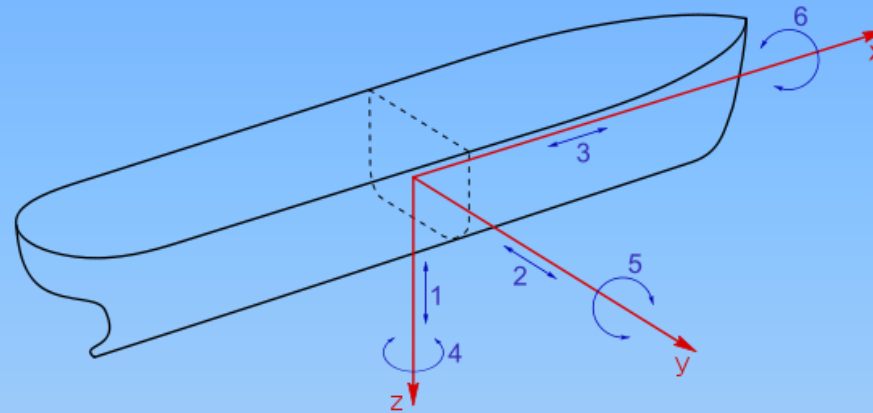

Ship's movements with 3 axes, 6 freedom degrees :

Translation: 1- heave, 2- sway, 3- surge
Rotation: 4- yaw, 5- pitch, 6- roll.

These movements introduce bias due to inertia's ship



1st solution: use a fixed Antenna on a ship

Advantage:

No problems for power and datalogging

Easy to install

Question:

How to deconvolve ship's movement of the signal?

Answer:

Use the inertial navigation system and gyrocompass of the ship

Question: ok, and how synchronise GPS Data with inertial navigation system Data?

Answer: with electronic and software device

but need post processing calculation

(need to wait 3 weeks for satellite data ephemeride)

2nd solution: tow an antenna fixed on a small rigid structure

Advantage:

Avoid the ship movements

Question:

How to do for having power and datalogging for long time?

Answer:

Put energy supply and datalogger on the ship
or use a cable between the antenna and the ship

Question: At different speeds, the boat may sink or squat into the water (planning phenomena), thus changing the height of the antenna, how to monitor it?

Answer: calibrate the height at different speed:
monitore the speed for each satellite data...

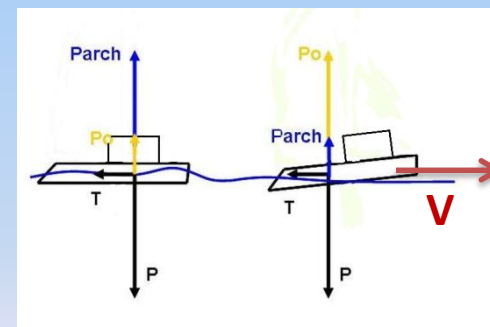



3) Seaweed sheet concept:

Algae stay at the sea surface and follow exactly the swell and waves without extra movements



how to fix an antenna on seaweed and tow it?





Geodetic calibration system: CalNaGeo

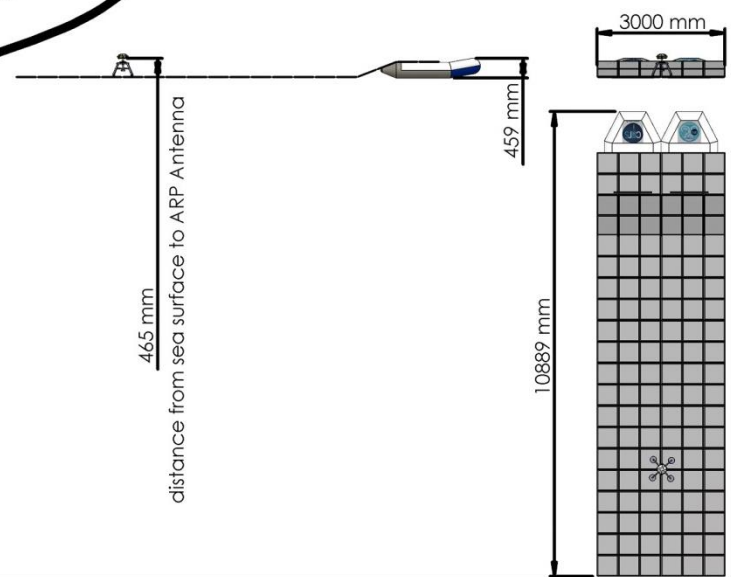
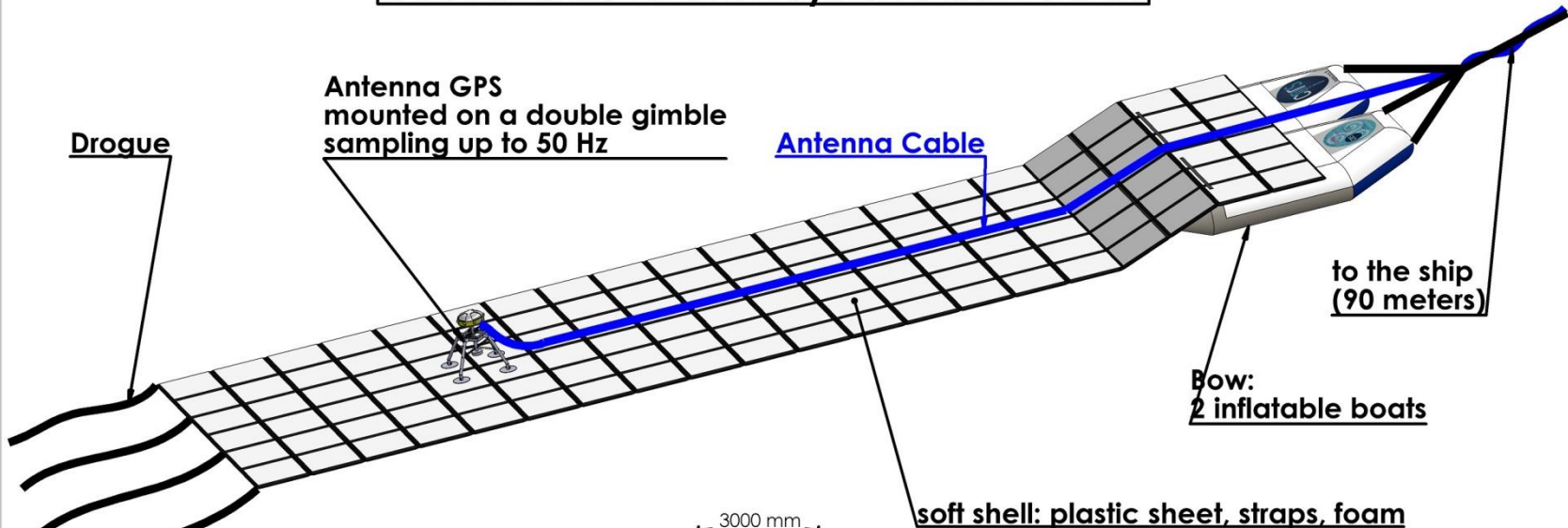

CalNaGeo_en

Division Technique de l'INSU			
Matière:	Usinage js-JS12	Rayon non coté: R=1	
Protection:	Tol.	Perçage js-JS11	Chanf. non coté: 1x45°
Trait.Therm.:	Gén.	Etat de surface: Ra 1,6	
Modifié le		Filetage qualité moyenne 6H-6g	
Dessiné par M.Calzas le:16/06/2014			
ENSEMBLE: Nappe Géodésique		PROJET: FOAM	
Nom de la pièce: CalNaGeo_en		Nombre de pièce:	N°: 00

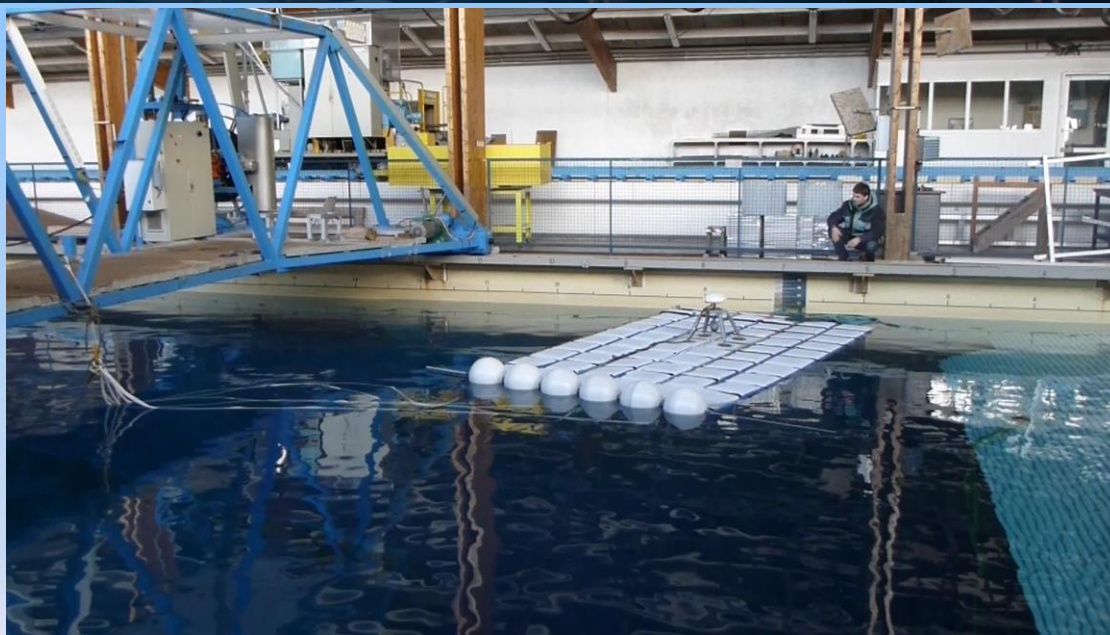
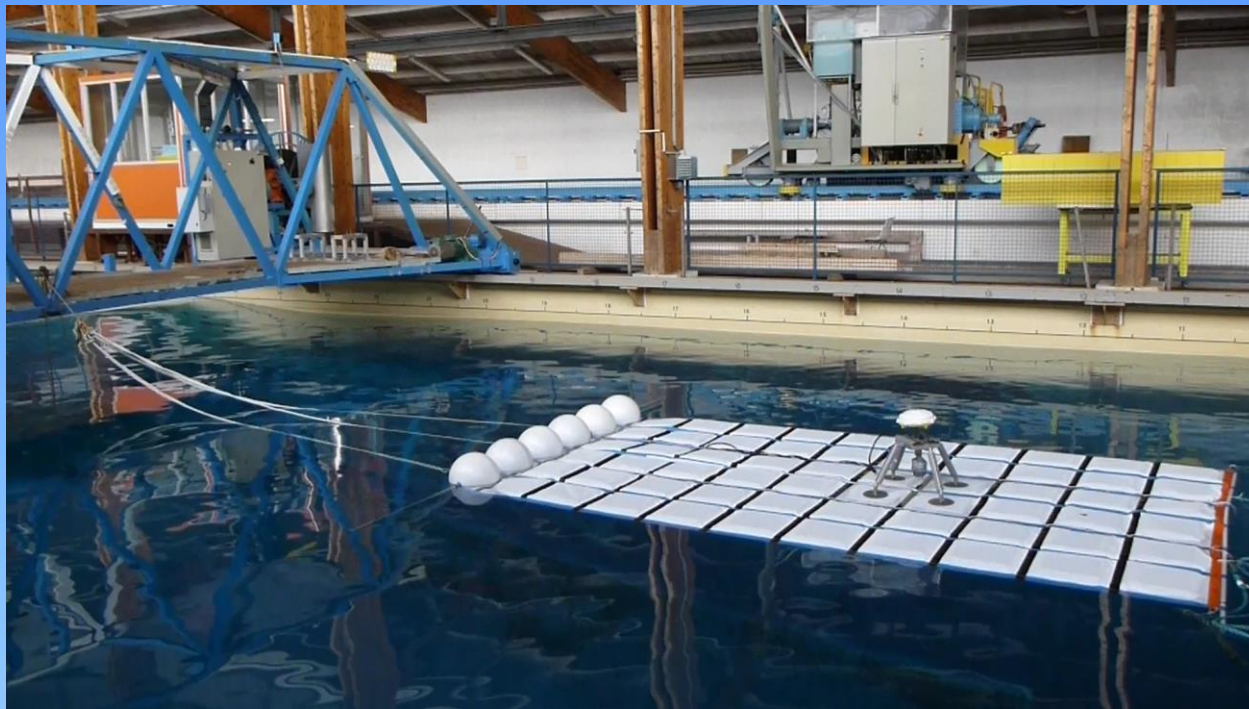

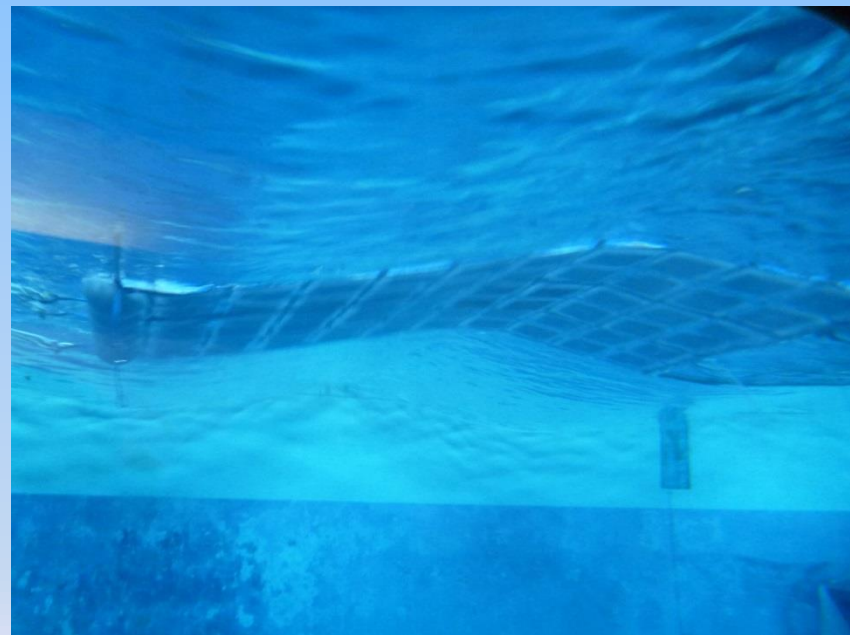
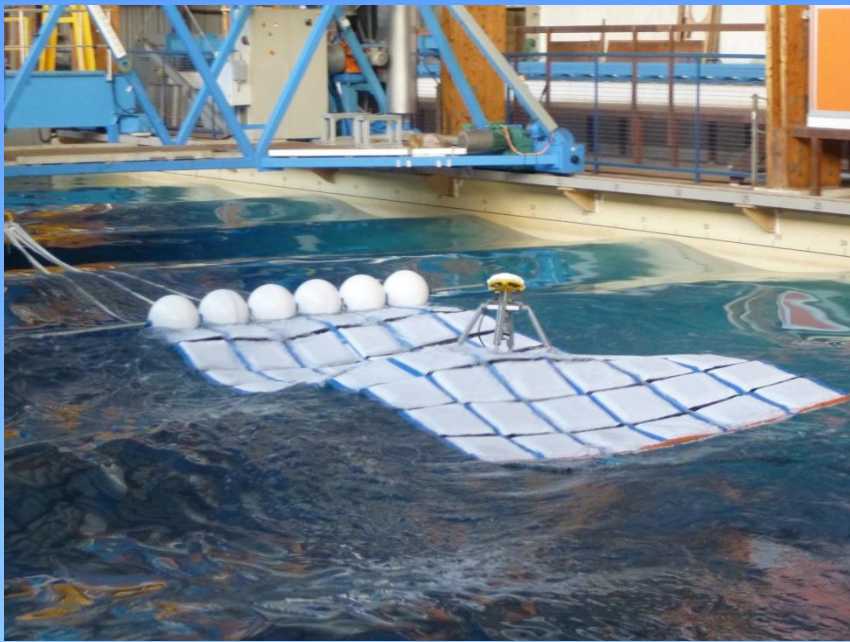

Rugged antenna



Double gimbal

Suspension (elastic wires)



Films tests bassins et en mer



Après quelques modifications (étrave, longueur, étanchéité électronique Transmission trame NMEA, lests, etc, etc) on a aboutit à ce système:



Version hauturière



Version côtière





Test rade de Brest



Mesures dans le Golfe du Bengale



Test large de la Rochelle





The towed GPS buoy: CalNaGEO

The system consists of a geodetic GNSS antenna on a soft shell (to avoid artefacts due to rigid structures) to follow the sea surface. The antenna is gimballed and towed (up to 10 knots) by a ship. This is used for in-situ CAL/VAL calibration of altimetric height (SSH for ocean surfaces), geoid measurement and waves monitoring (up to 50 Hz).

These developments are founded by CNES (Centre National d'Etudes Spatiales) project FOAM (From Ocean to inland waters Altimetry Monitoring).

PI: Pascal Bonnefond, Astronome, Observatoire de Paris
Conception: DT INSU

But de la mission FOAM:

- Mesurer le géoïde local
- Rattacher les mouillages au point de référence géodésique de PAF
- CAL/VAL satellite Jason 3-3, Sentinel 3, Saral-Altika
- Préparer CAL/VAL SWOT

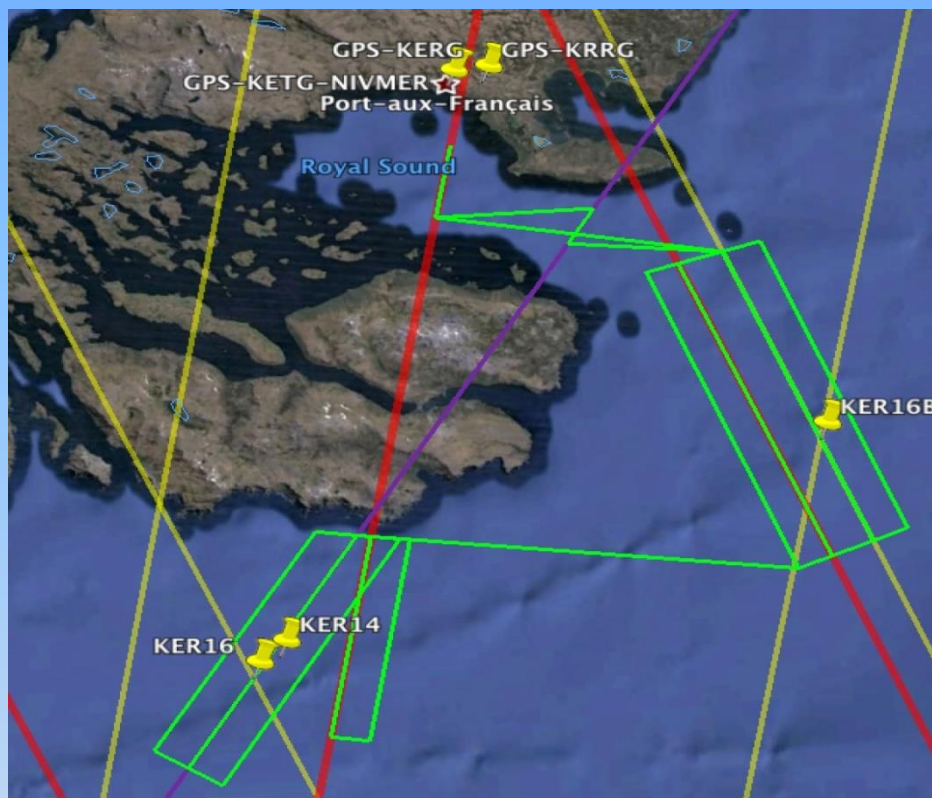

Traces des satellites survolant Kerguelen (missions TOPEX/Poseidon et Jason en violet ; missions ERS-1&2, Envisat et SARAL/AltiKa en jaune ; mission Sentinel-3A en rouge) et trajet prévu par la nappe flottante CalNaGeo (en vert).

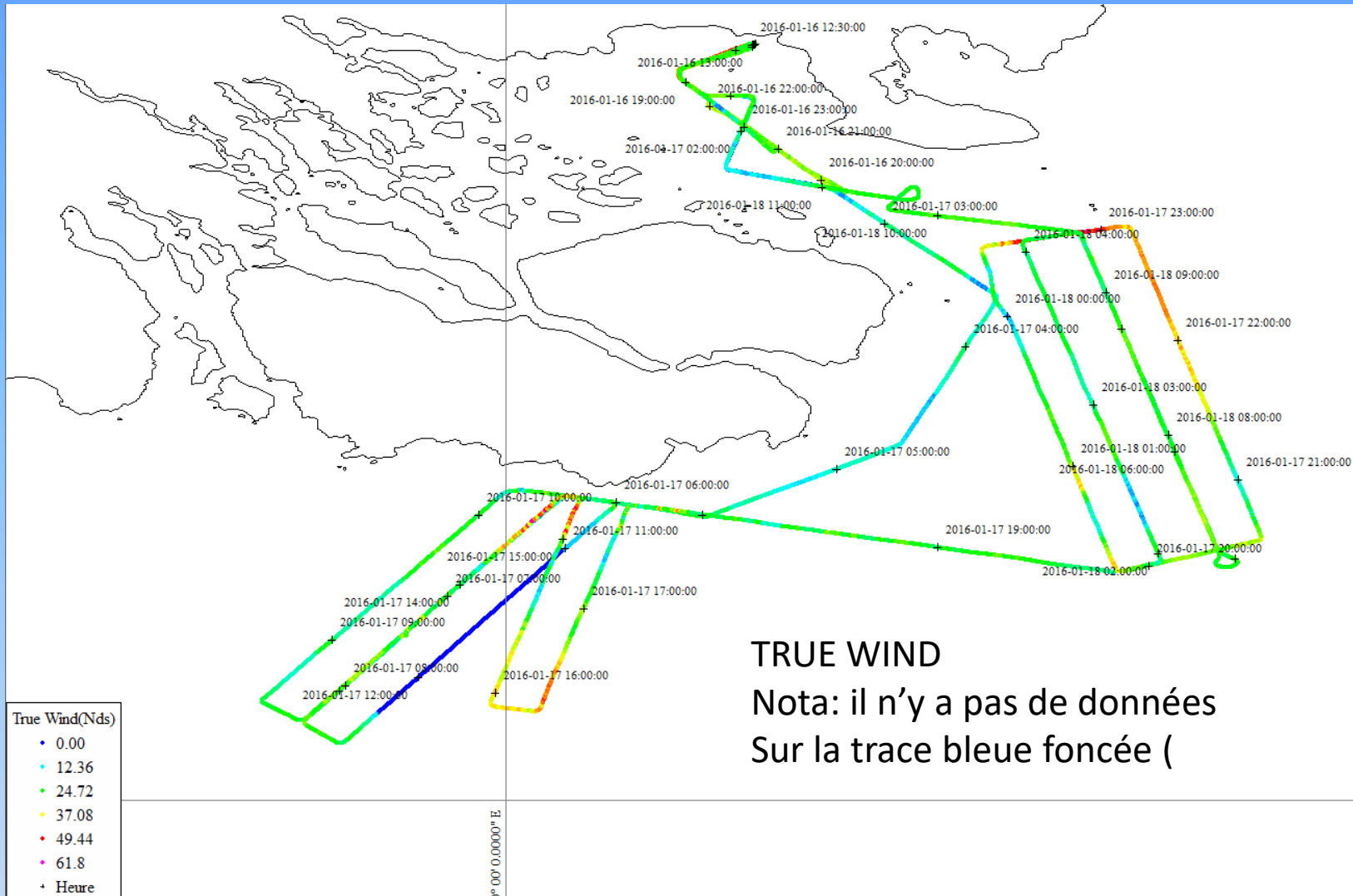



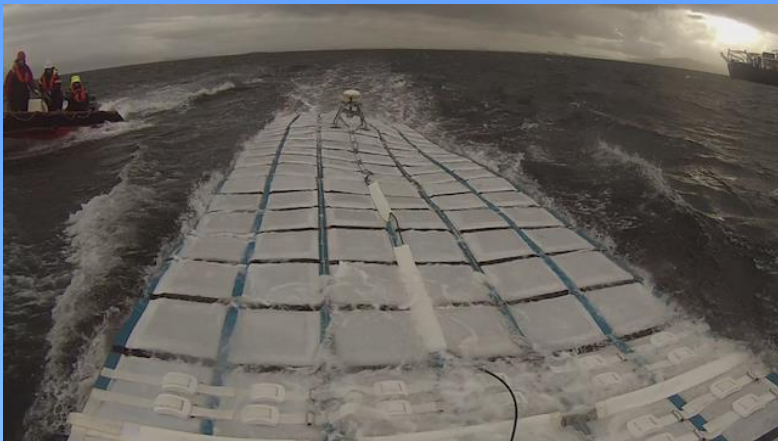

REFMAR 29/03/2019

michel.calzas@cnrs.fr



Film CalNaGEO aux Kerguelen

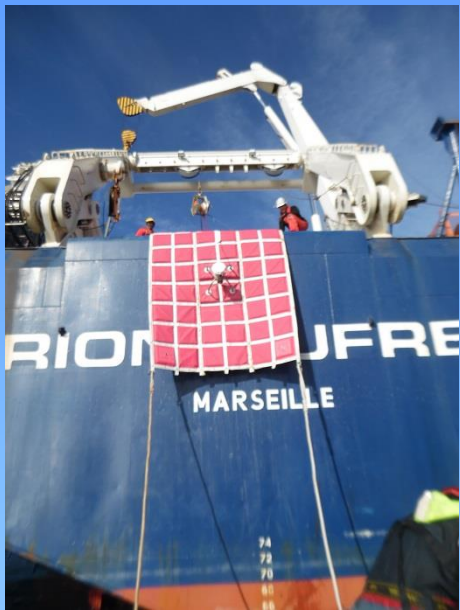

PC scientifique: écrans de contrôle pour CalNaGEO





PC scientifique



Bouée GNSS au mouillage



Marégraphe à PAF



Station de base GNSS mobile



Corsica calibration site in 2015: 16 years after the geoid computation



CalNavGeo experiment (Senetosa 18/06/2015): mode short (turquoise) / mode none + ambin (orange)

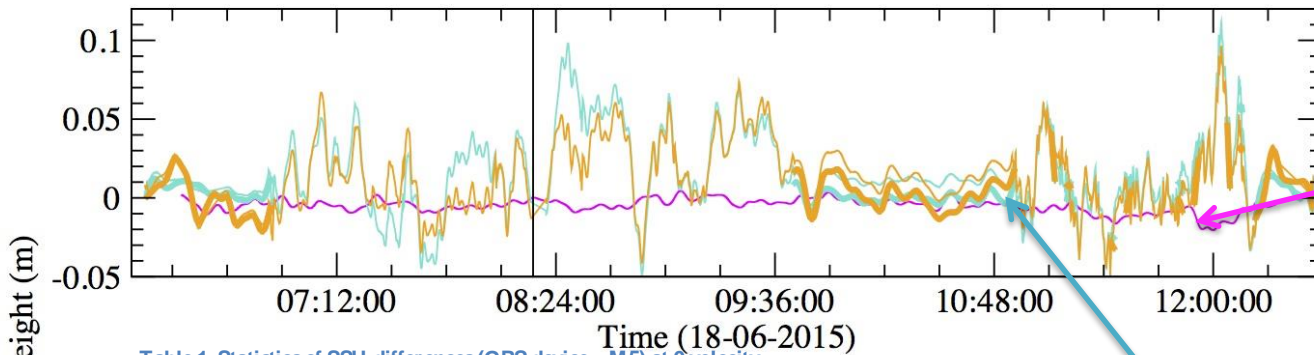

zodiac

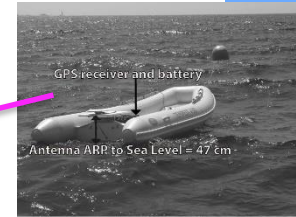
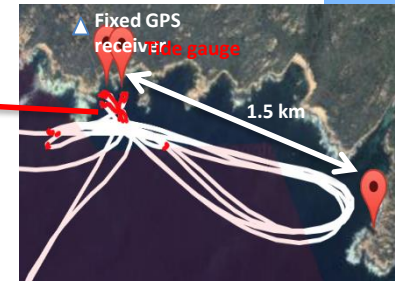

Table 1. Statistics of SSH differences (GPS device - M5) at 0 velocity

	Mean (mm)	Standard Deviation	Number of data
Zodiac	-5.0	4.4	21551
CalNaGeo	+1.4	4.2	5300

Table 1. Linear trend of SSH differences (CalNaGeo - Tide gauges) as a function of velocity

	Bias @ 0 m/s (mm)	Slope (mm/(m/s))	Number of data
M3&M5	+2.77 ± 0.09	+2.56 ± 0.07	7861
M3&M5 (0<V<4)	+3.48 ± 0.07	+0.06 ± 0.07	7597
M3&M5 (0.5<V<4)	+5.73 ± 1.0	+0.86 ± 0.34	980



GPS - Tide gauge Sea Surface Height (m)

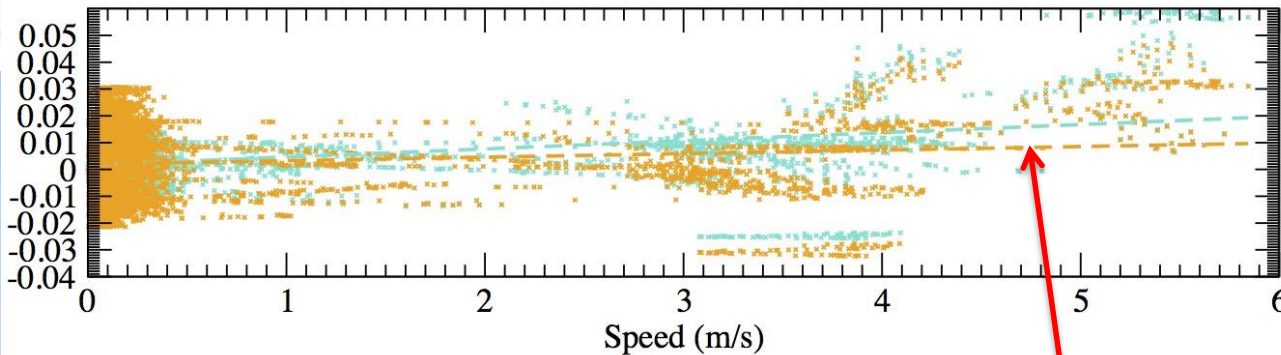

No waterline dependency with the velocity (<1 mm / (m/s))

Corsica calibration site in 2015: 16 years after the geoid computation



CalNavGeo experiment (Senetosa 18/06/2015): mode short (turquoise) / mode none + ambin (orange)

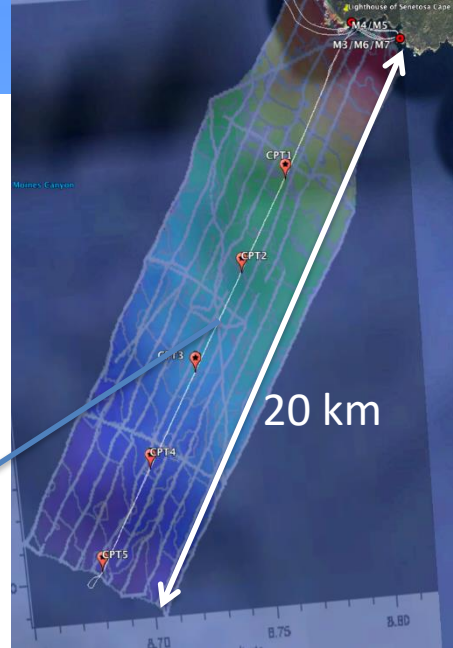
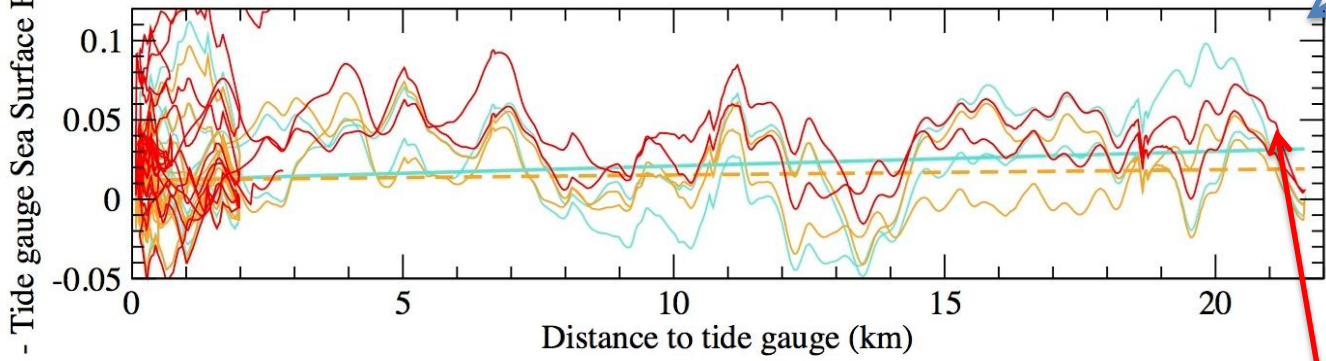
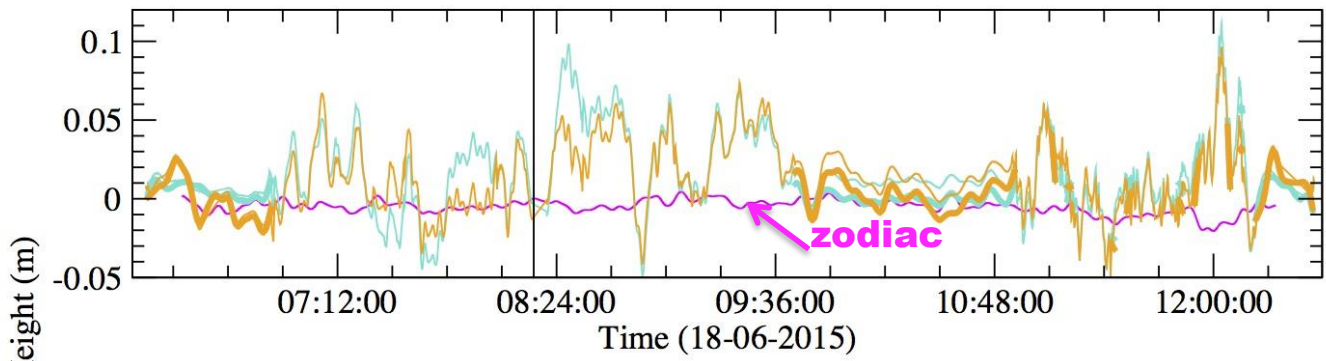

Gipsy PPP solution:
Differences between the outward and the return journey are smaller



Campagne sur la Seine:

Comparaisons avec les marégraphes



Différences Aller-Retour:

Moyenne: -25mm

Std: 36mm



M10 (Aizier) et peut-être aussi M11 (St Léonard) semblent avoir un problème de référencement car biaisés autant à l'aller qu'au retour

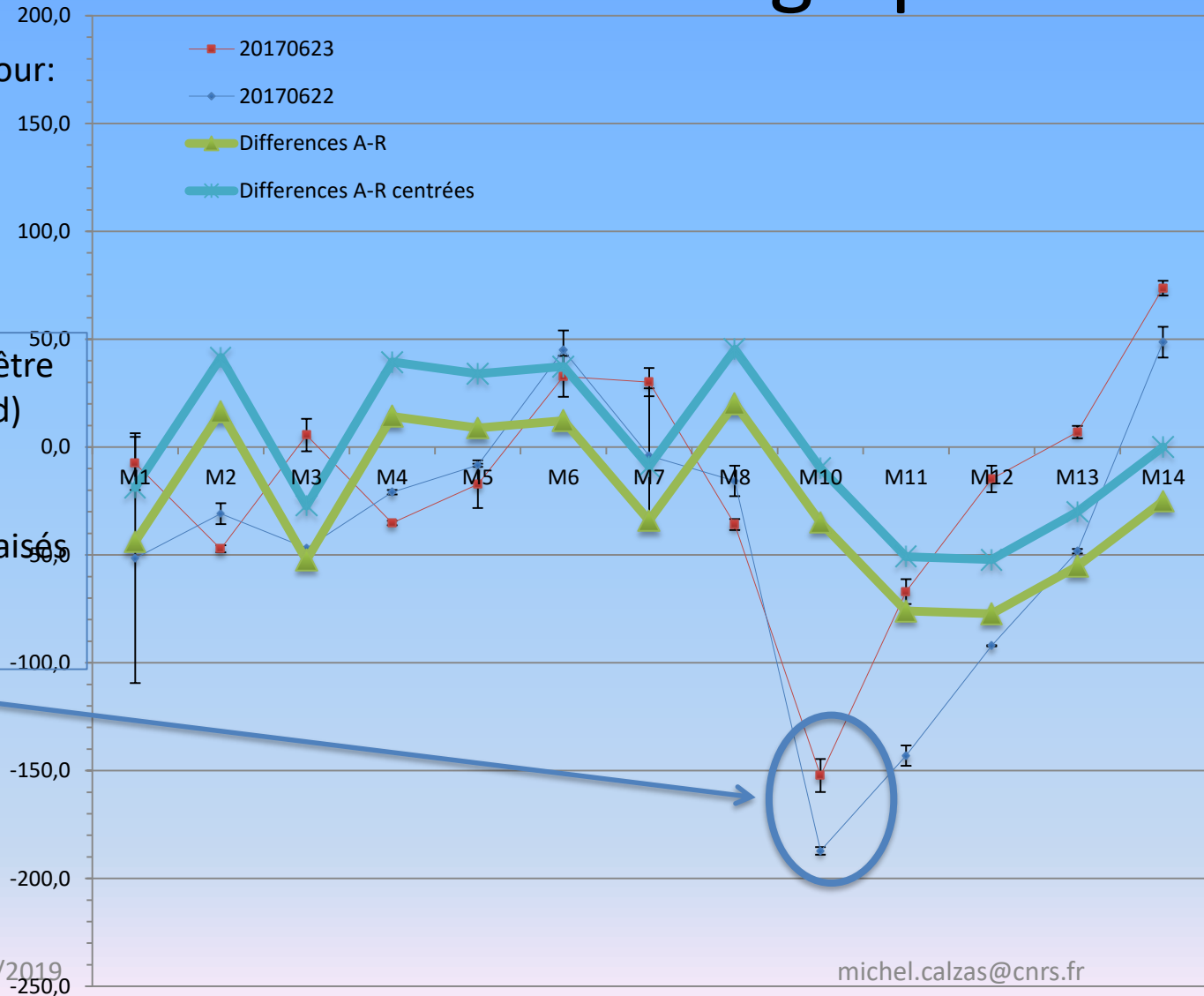



Quelques chiffres:

RH: Depuis 2014: **1,5 ETPT/an** personnels DT INSU, soit 6 ETPT depuis le début du projet

Conception réalisée par:

Cédric Brachet, Antoine Guillot, Michel Calzas, Lionel Fichen **DT INSU**

Coût prototype (non consolidé): 100 k€

Coût (non consolidé) d'un système actuel: **40 k€**

Sous-traitance: Réalisations mécaniques, maître voilier pour nappe, fabricant récepteur GNSS

Missions effectuées par: Christine Drezen, Cédric Brachet, Antoine Guillot, Michel Calzas, Pascal Bonnefond, Olivier Laurain, Claude Gaillemin, Stéphane Calmant, Etienne Poirier, Dominique Mahé

Lieux des missions: Senetosa (Corse), Rade de Brest, Pertuis, Golfe du Bengale, la Seine, la Gironde, Iles Kerguelen

Prévisions: Amazonie, Vanuatu, Lac Issy Kul, Baléares pour CAL/VAL Satellite SWOT



Nouveau système: Cyclopee

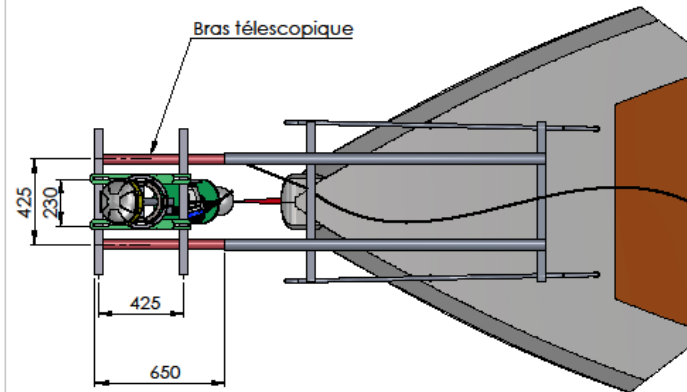
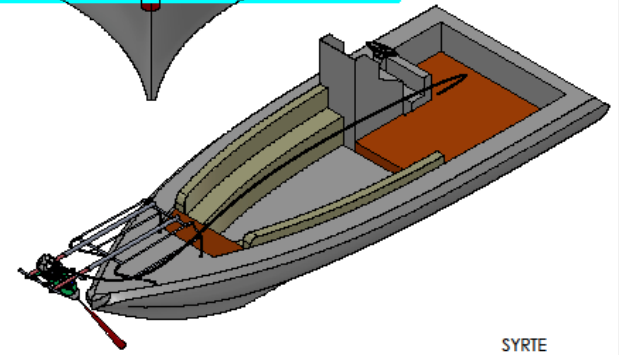
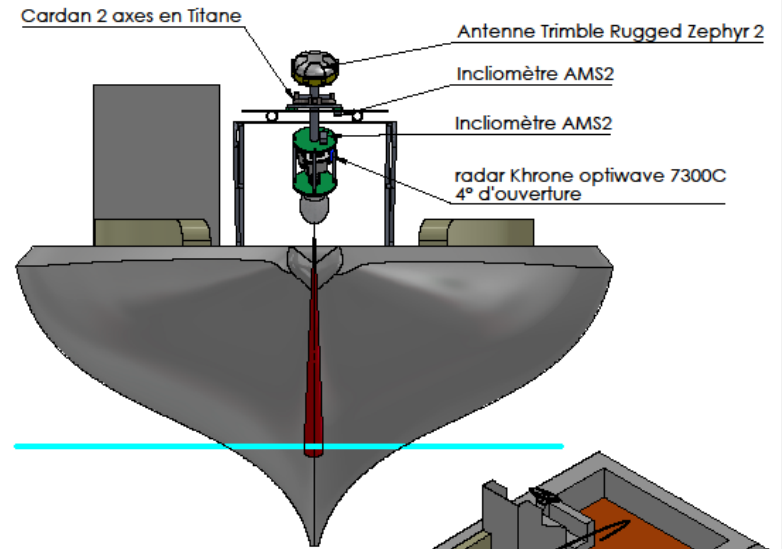
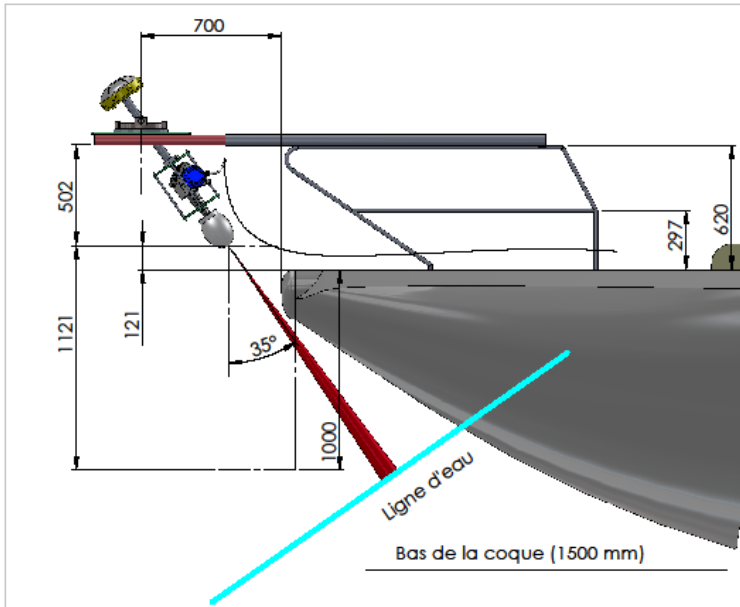

		Division Technique de l'INSU		SYRTE	
Protection: Tol. Perçage js-JS11		Chanf. non coté: 1X45°		ECH: 1:50 3D 1:20 2D A3	
Modifié par le		Gén. Etat de surface: Ra 1,6		Filetage qualité moyenne 6H-6g	
Vérifié par		Dessiné par M. Calzas le 21/04/16		ENSEMBLE: Implantation Cardan PROJET: CYCLOPEE	
Nom de la pièce: Synoptique 35° AXE tangage		N°: 00a		N°: 00a	



Merci de votre attention